

03250952

1000106001-002-06

Honeywell

www.docuthek.com

Operating instructions for operators and installers
Electronic index EI2

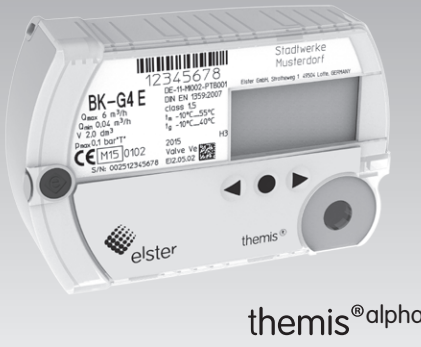

Contents

Electronic index EI2 1

Contents 1

Safety 1

Checking the usage 2

Installation 2

Operating the electronic index 2

Navigating within the menu 3

Service mode 5

Establishing an optical communications link 7

Changing the battery 7

Setting the index parameters 8

Releasing the valve 8

Retrofitting/replacing the communication module 9

Check test 9

Assistance in the event of malfunction ... 14

Spare parts 14

Technical data 15

Logistics 15

Contact 16

Safety

Please read and keep in a safe place



Please read through these instructions carefully before installing or operating. Following the installation, pass the instructions on to the operator. This unit must be installed and commissioned in accordance with the regulations in force. These instructions can also be found at www.docuthek.com.

Explanation of symbols

- , **1**, **2**, **3**... = Action
- > = Instruction

Liability

We will not be held liable for damage resulting from non-observance of the instructions and non-compliant use.

Safety instructions

Information that is relevant for safety is indicated in the instructions as follows:

⚠ DANGER

Indicates potentially fatal situations.

⚠ WARNING

Indicates possible danger to life and limb.

! CAUTION

Indicates possible material damage.

All interventions may only be carried out by qualified gas technicians. Electrical interventions may only be carried out by qualified electricians.

Conversion, spare parts

All technical changes are prohibited. Only use OEM spare parts.

Changes to edition 12.13

The following chapters have been changed:

- Checking the usage
- Logistics

Checking the usage

Electronic index EI2.00, EI2.05, EI2.06, EI2.11 for diaphragm gas meters BK-G...E, BK-G...ET or BK-G...Ete

Electronic index for reading out absolute meter readings and for retrieving consumption data, current tariffs, messages and the valve position.

This function is only guaranteed when used within the specified limits – see page 15 (Technical data). Any other use is considered as non-compliant.

Type code

Code	Description
EI2	Electronic index based on EI2 Variant
.00	Zigbee with valve Vs
.05	Zigbee with valve Ve
.06	Zigbee, valve Vs, top reading
.11	Zigbee, valve Ve, top reading
	Communication module
.00	None
.02	ECM.02 (Zigbee)
.10	ECM.10 (Zigbee SMETS 1)

- ▷ The index version is shown on the index plate, see page 2 (Type label/Index plate).
- ▷ When retrofitting or replacing the communication module, it may be the case that the last two characters in the type code are no longer applicable.

Part designations

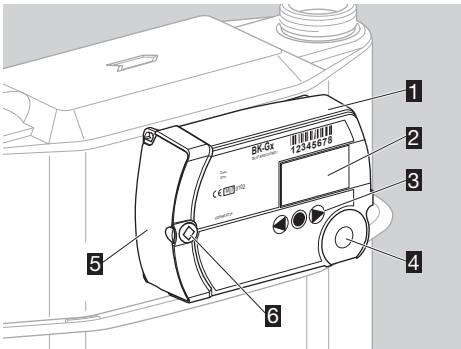

- 1 Electronic index EI2
- 2 Display
- 3 User keys
- 4 Opto-adaptor interface
- 5 Service cap
- 6 Installation seal/screw locking cap

Type label/Index plate

Please quote for all enquiries:

- ▷ Manufacturer's serial number S/N (at the bottom left)
- ▷ Index version EI (next to the serial number)

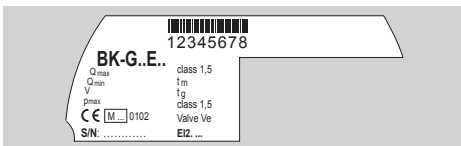

ATEX

- ▷ The electronic index is suitable for use in potentially explosive atmospheres. For the exact use (zone), see ATEX sticker on the diaphragm gas meter or see the operating instructions for diaphragm gas meters BK-G1.6 to BK-G25 → http://docuthek.kromschroeder.com/doclib/main.php?language=1&folderid=400041&by_class=2&by_lang=-1.

Installation

Installing the gas meter

- ▷ For installing the gas meter in the pipework, refer to the operating instructions for diaphragm gas meters BK-G1.6 to BK-G25 → http://docuthek.kromschroeder.com/doclib/main.php?language=1&folderid=400041&by_class=2&by_lang=-1.

Gas meter with integrated valve

- ▷ If the integrated shut-off valve in the gas meter is closed, it must be released, see page 8 (Releasing the valve).

Operating the electronic index

- ▷ The display on the index is switched off.
- Briefly press any key.



- ▷ A beep sounds and the main screen appears.
- ▷ An internal buzzer gives audible feedback, e.g. a short beep indicates a valve is open and a long beep indicates a valve is closed. A short beep sounds each time a key is pressed or if the unit automatically changes back to the main screen.
- ▷ This function can be switched off, see page 8 (Setting the index parameters).

Main screen

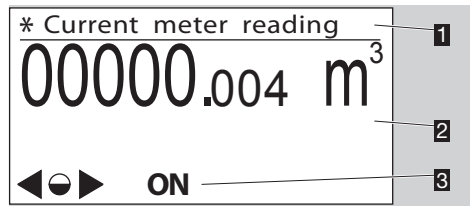

- 1 Menu area
 - 2 Information area
 - 3 Status line (symbols)
- ▷ The **ON/OFF** symbols are only displayed when a valve is integrated in the gas meter.

User keys, selection key and symbols

- ▷ You can navigate through the menu using the user keys **▶**, **◀** and the selection key **●**.

Symbol	Meaning
▶ , ◀	Navigate to the left or the right on each level using the user keys. Briefly pressing the selection key selects a sub-menu.
●	Holding the selection key pressed down switches the display back to the previous menu.
◐	Briefly pressing the selection key selects a sub-menu.
◑	Holding the selection key pressed down switches the display back to the previous menu.
▶ , ○ , ◀	Keys inactive
OFF	Valve/gas flow closed. This symbol is only displayed when a valve is integrated in the gas meter.
ON	Valve/gas flow released. This symbol is only displayed when a valve is integrated in the gas meter.
	New messages
	Invalid data
	Error message
	Low battery. This symbol is only displayed when battery power is low.
*	Marking for metrology-relevant data
□	Substitute for undisplayable character in sentence

- ▷ In the “Icon definitions” menu, the most important symbols are described briefly.

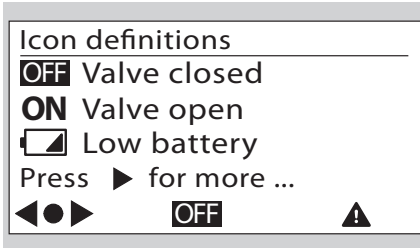

Navigating within the menu

- ▷ The menu is constructed hierarchically.
- ▷ Depending on the configuration, some menus may be missing.
- ▷ The “Current meter reading” main screen appears when switching on the index.
- ▷ If you are in a different menu, the display will automatically change back to the main screen when no user key has been pressed for 30 s, and switches off after a further 30 s.
- ▷ You can navigate from the main screen to the various menus, such as “Meter information” using the user keys **▶**, **◀**.

Menu overview

The display can differ depending on the parameterization or communication module.

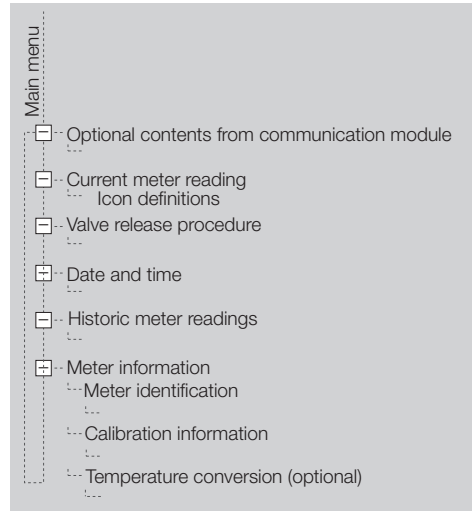

Optional contents from communication module

- ▷ For further information, refer to the operating instructions for communication modules type ECM (for electronic index).

Current meter reading

- ▷ The absolute meter reading and optionally the current tariff are indicated in the main screen.
- ▷ This appears when switching on the index.
- ▷ You can receive information about the symbols by pressing the selection key **●** and the user keys **▶**, **◀**, or see page 3 (User keys, selection key and symbols).

Valve release procedure

- ▷ If the valve was released while the display was switched off, the release note will appear the next time the index is switched on.



- ▷ The note remains active until the valve has been released, see page 8 (Releasing the valve).
- ▷ If the selection key **●** is not pressed, the display will switch back to the main screen after 30 s.

Date and time

- ▷ Information on the date and time display.

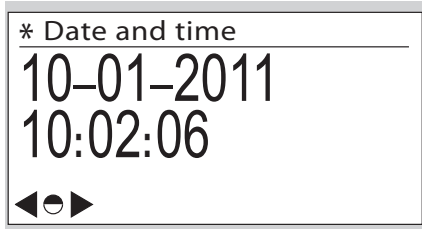

- ▷ The operator can transfer the switchover between winter and summer time to the communication module, provided that it supports this.
- ▷ The date is given in the format day - month - year.
- ▷ The date format can differ depending on the market.
- ▷ This display is only visible if access to the historic meter readings has been activated.

Historic meter readings

- ▷ Consumption data dating as far back as 60 weeks can be called up.

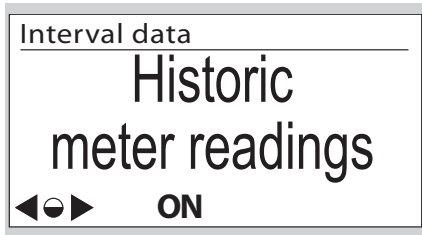

- ▷ The historic meter readings can be viewed as an option. Depending on the parameterization, access to the historic meter readings can either be
 - fully activated or
 - protected by entering a password or
 - deactivated.
- ▷ By pressing the selection key ●, consumption data are displayed, which are given by month, week or day, or 4-hour or 1/2-hour intervals.

“4 hour summary” example:

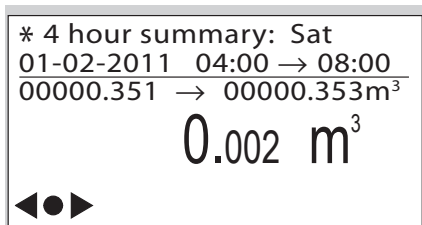

- ▷ The timeframe is displayed with date and time for the start and end of the period.
- ▷ The meter reading is displayed for the start and end of the period in m³.
- ▷ The consumption for this period is indicated in m³.
- ▷ The tariff band may be displayed.

Electronic index with communication module:

- ▷ The ⚠ symbol is displayed if, for example, the tolerance between the internal time recording and the actual time is too large. This can lead to invalid consumption data. After the next time synchronization, the consumption data are recorded again correctly and ⚠ disappears.

Meter information

- ▷ Meter-specific technical data are displayed in sub-menus by pressing the selection key ● several times.



Meter identification:

- No.: (Owner's meter number)
- EN 1359 Reg. No.: NG-4701BM0443 (example)
- Firmware version
- CRC (checksum)
- Details (firmware details)
- ▷ For further information, see page 15 (Technical data).

Calibration information:

- Meter calibration parameters Q1 to Q3 (adjustment values Q1 to Q3 for three-point calibration)
- Cyclic meter volume

Temperature conversion (optional):

- Type of conversion (mechanical or electronic)
- Base temperature t_b (in accordance with EN 1359)
- Specified centre temperature t_{sp} (in accordance with EN 1359)

Service mode

Part designations

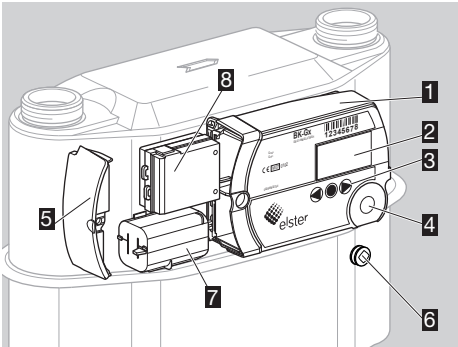

- 1** Electronic index EI2
 - 2** Display
 - 3** User keys
 - 4** Opto-adaptor interface
 - 5** Service cover
 - 6** Installation seal/screw locking cap
 - 7** Battery
 - 8** Communication module (optional)
- ▷ In Service mode, meter-specific operating data can be called up.

Activating Service mode

- 1** Hold the selection key ● pressed down.
 - ▷ A pixel will appear in each corner of the display.
 - 2** Observe one pixel: while the pixel is visible, hold the selection key ● pressed down. Release the key as soon as the pixel has disappeared.
 - 3** Repeat the process, until all the pixels are off and "Test instructions" appears in the menu area.
- ▷ Service mode is activated.

Service mode menu overview

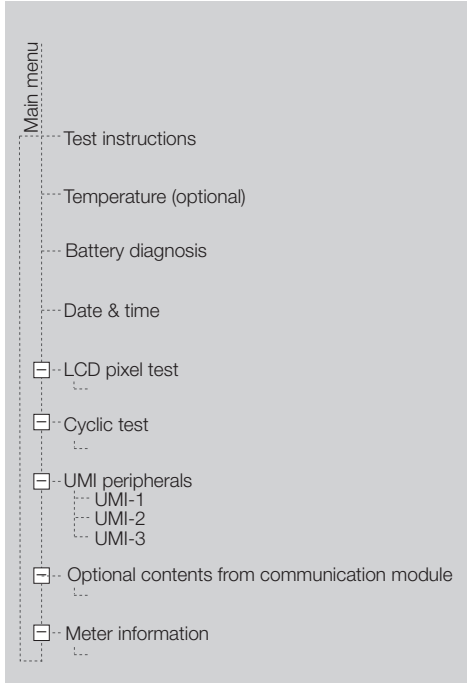

Test instructions

Test instructions

Automatic return to main menu after 5 minutes of inactivity

Hold ● on any screen to return immediately

◀ ● ▶ ON

Temperature (optional)

- ▷ This menu is available if temperature conversion has been activated.

*** Temperature**

tg 25.04°C

TC: electronic

tg : [-10, 40]°C

tsp: 20°C

tb : 0°C

OFF

◀ ● ▶

- tg currently measured gas temperature t_g
- TC: type of temperature conversion
 Electronic: mathematical conversion to t_b in index
 Mechanical: mechanical conversion to t_b in measuring unit

- tg: [] max. allowable gas temperature range
t_g [min. value, max. value]
- tsp: specified centre temperature t_{sp} (in accordance with EN 1359)
- tb: base temperature t_b (in accordance with EN 1359), see page 15 (Technical data)
- ▷ Check test for temperature test, see page 9 (Check test).
- ▷ The measured value is updated once per minute.

Battery diagnosis

- ▷ When the battery is connected, the status "OK" is shown in the display.

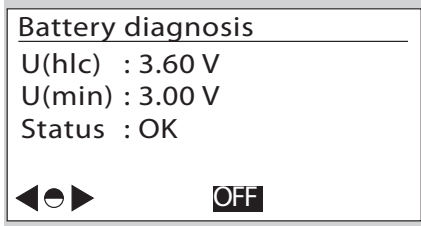

- The U(hlc) value indicates the current voltage measured on the battery or HLC.
- The U(min) value signals the minimum voltage measured on the battery or HLC.
- ▷ If battery power is low, the display changes to the status "Change required". The battery must be changed within a short time.

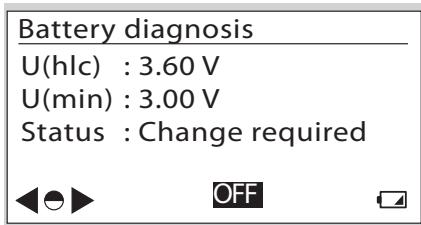

- ▷ Having disconnected the battery, the display switches to the status "Removed".

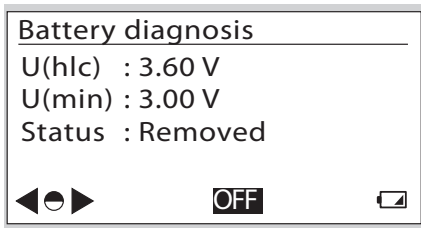

Date and time

- ▷ Information on the date and time display.



- ▷ The operator can transfer the switchover between winter and summer time to the communication module, provided that it supports this.
- ▷ The date is given in the format day - month - year.
- ▷ The date format can differ depending on the market.
- ▷ This display is only visible if access to the historic meter readings has been activated.

LCD pixel test

- ▷ A display test can be carried out in this menu.

- 1** Follow the displayed instructions.
- ▷ A test pattern is shown in the display.
- 2** Briefly press the selection key ●.
- ▷ A further test pattern appears in the display.
- 3** Hold the selection key pressed down. The display switches to the previous menu.

Cyclic test

- ▷ The accuracy of the meter can be checked using a cyclic test.

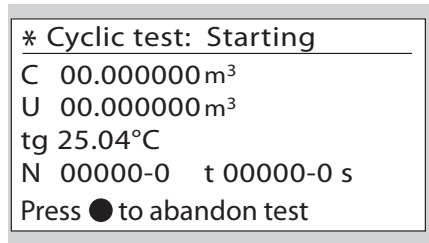

- C = converted volume (temperature only)
for BK-G...E: no function (C = U)
for BK-G...ET: C = V_{b15}, conversion to t_b = 15°C
for BK-G...ETe: C = V_b, conversion to t_b (see page 15 (Technical data))
- U = non-converted volume V_P
for BK-G...ET: U = converted volume V_{b15}
- ▷ The conversion takes place in the measuring unit.
- tg = measured gas temperature in °C
- N = number of complete measuring cycles (measuring unit revolutions) – number of intermediate sampling points in the measuring cycle (max. 8)
- t = total testing time in seconds
- ▷ for BK-G...ETe, the following applies:
The relationship between V_b and V_P is as follows:
V_b = V_P × T_b / T_g

where $T_b = (273.15 + \{t_b\}) K$

$T_g = (273.15 + \{t_g\}) K$



t_b is specified in the technical data, see page 15 (Technical data).

- ▷ The curly brackets mean “numerical value of”.
- ▷ For detailed information on the check test operating sequence, see page 9 (Check test).

UMI peripherals

- ▷ The status of the available interfaces for optional communication modules is displayed.

Meter information

- ▷ Meter-specific technical data are displayed in sub-menus by pressing the selection key  and the user keys , .

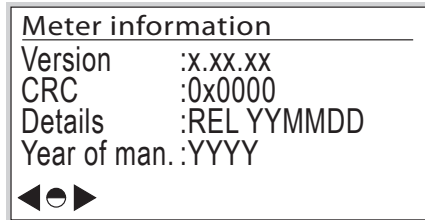

Meter information:

- Software version
- CRC: software checksum
- Software details
- Year of manufacture
- ▷ Other screen descriptions (not illustrated):

Calibration information:

- Meter calibration parameters Q1 to Q3 (adjustment values Q1 to Q3 for three-point calibration)

Meter characteristics:

- Cyclic meter volume
- Transitional flow rate Q_t
- EN 1359 Reg. No.: NG-4701BM0443 (example)

Ambient conditions:

- Electromagnetic
- Mechanical

Establishing an optical communications link

- ▷ Depending on customer requirements, the optical interface can be locked.
- ▷ In order to configure the electronic index for the respective application, the optical communications link must be activated.

- 1 Position the opto-adaptor head on the interface provided.

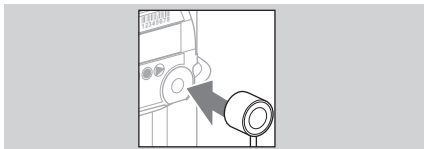

- 2 Press any user key.
- ▷ Optical communication is enabled for 1 minute.

- ▷ If the optical communications link is not used during this time, the interface will be deactivated.

- 3 Initiate communication.

- ▷ The procedure depends on your user software.
- ▷ For further information, refer to the operating instructions for communication modules type ECM (for electronic index).

Changing the battery

⚠ WARNING

Risk of explosion in explosion-hazard areas!

- As a general rule, maintenance and repair work should be avoided in explosive atmospheres.
- Check that the electrical system complies with the special electrical explosion protection requirements.
- When working on electrical equipment in an explosion-hazard area, only design-approved electrical operating equipment may be used.
- Use original spare parts supplied by Elster GmbH, see page 14 (Spare parts).

- ▷ The battery is available as a spare part.

- 1 Prepare the index for changing the battery.

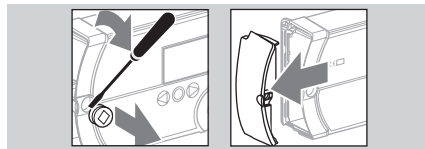

- ▷ The battery can only be replaced when the optical communications link has been established, see page 7 (Establishing an optical communications link). Otherwise, data can be lost.

- 2 Start the battery change procedure.

- ▷ The procedure depends on your user software.
- ▷ Important! The battery may only be removed once a release message has been issued by the index. Otherwise, an integrated valve will be closed and/or an error message will be transferred via the communication module.
- ▷ The index confirms disconnection of the battery with a sound sequence.

- 3 Replace the battery as quickly as possible.

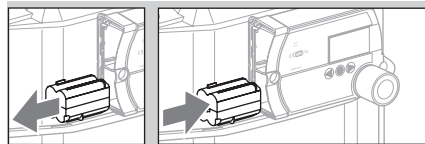

- ▷ The index confirms connection of the battery with a sound sequence.
- ▷ The main screen appears when any key is pressed.
- ▷ Optical communication is enabled for 1 minute. If the optical communications link is not used during this time, the interface will be deactivated.

- 4 Reprogram the battery parameters.
 - ▷ The procedure depends on your user software.
- Electronic index without communication module:
 - ▷ After the battery has been replaced, check the time and update it if necessary. Note the global UTC format.
- 5 Replace the service cover.
- 6 Push in a new screw locking cap, see page 14 (Spare parts). The body carrying out this task should apply its own seal.

Setting the index parameters

The following index parameters can be adjusted using the user software:

- properties of the historic values screen,
- time display,
- audible feedback when a key is pressed,
- parameters for valve release procedure.

Releasing the valve

- ▷ If a valve is integrated in the diaphragm gas meter BK, this must be released/opened for commissioning.

! CAUTION

To avoid damage:

- Ensure the customer's consumers are closed.
- ▷ The valve can only be released when the optical communications link has been established or via a communication module.
- ▷ Unless otherwise agreed, the valve is open on delivery as standard.
- ▷ Once the valve has been released via the communication module, this must be confirmed at the meter on site by the consumer or another person if applicable.

- 1 Establish the optical communications link, see page 7 (Establishing an optical communications link).
- 2 Release the valve. The procedure depends on your user software.

Valve open safety check

**CHECK IF
APPLIANCES OFF
HOLD ● FOR GAS**

- ▷ The test procedure may differ from the description.
- ▷ Press the selection key ● and hold down.

- ▷ After a short time, the unit switches to initialization mode.

Opening valve

Please wait



- ▷ After successful initialization, the gas flow check is started. The test duration is shown in the display.

Gas flow check in progress

**Max time: 00:29:56
Min time: 00:06:08**



- ▷ Once the release criteria have been checked, the results are shown in the display.

Gas flow check complete

**Gas flow check
successful**



ON



Retrofitting/replacing the communication module

⚠ WARNING

Risk of explosion in explosion-hazard areas!

- As a general rule, maintenance and repair work should be avoided in explosive atmospheres.
 - Check that the electrical system complies with the special electrical explosion protection requirements.
 - When working on electrical equipment in an explosion-hazard area, only design-approved electrical operating equipment may be used.
 - The communication module may only be pulled out if it has first been deactivated.
 - When installing a communication module, ensure that the communication interface has been deactivated.
 - Further information can be found in the operating instructions for communication modules type ECM (for electronic index).
 - Use original spare parts supplied by Elster GmbH, see page 14 (Spare parts).
- ▷ The communication module is available as a spare part.
- ▷ The communication module can only be retrofitted or replaced when the optical communications link has been established.
- ▷ The procedure differs depending on whether the communication module is to be retrofitted or replaced. See “Retrofitting the communication module” or “Replacing the communication module”.

Retrofitting the communication module

- ▷ Check the status of the interface and deactivate if necessary.

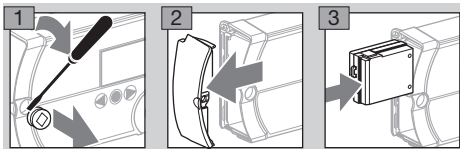

- 4** Establish the optical communications link, see page 7 (Establishing an optical communications link).
- ▷ The intended interface for the optional communication module is UMI-1.
- 5** The communication module and index must be paired.
- ▷ The procedure depends on your user software.
- ▷ Set the parameters of the communication module according to the instructions or the servicing steps provided by the relevant operator.
- 6** Replace the service cover.
- 7** Push in a new screw locking cap, see page 14 (Spare parts). The body carrying out this task should apply its own seal.

Replacing the communication module

- 1** Establish the optical communications link, see page 7 (Establishing an optical communications link).
- 2** Deactivate the respective communication module.

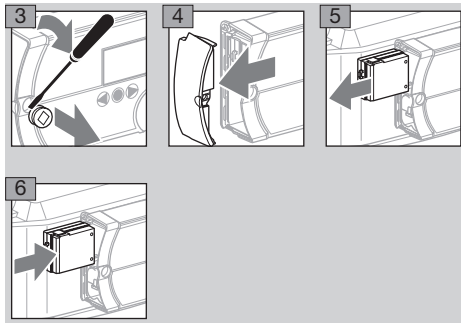

- 7** The communication module and index must be paired.
- ▷ The procedure depends on your user software.
- ▷ Set the parameters of the communication module according to the instructions or the servicing steps provided by the relevant operator.
- 8** Replace the service cover.
- 9** Push in a new screw locking cap, see page 14 (Spare parts). The body carrying out this task should apply its own seal.

Check test

Directive 2014/32/EU (MID) prescribes that it must be possible to check the meter.

- ▷ The requirements and test methods must comply with national laws and regulations.
- ▷ The following tests describe the check tests which are carried out by accredited testing agencies.
- ▷ Always conduct a pressure and temperature correction in accordance with established procedures (unit under test against master meter).
- ▷ Measurement accuracy class, see page 15 (Technical data).
- ▷ The unit under test must be acclimatized and installed on the test rig.
- ▷ Maintain the climatic conditions constant during the entire test duration. Otherwise, the test results will be inaccurate.
- ▷ Immediately before the beginning of the test, the quantity of test air, which corresponds to at least 50 x the cyclic volume of the meter to be tested, is fed through the meter at a flow rate of Q_{max} (maximum flow rate of a gas meter).
- ▷ During an active cyclic test, the display disappears after 5 minutes but lights up every minute for 10 seconds. This function is available for max. 5 hours.

- ▷ To conduct the tests, the thermowell and the pressure test point (if available) can be used as a reference for the temperature and pressure measured by the meter.

Cyclic test

The cyclic test is designed for checking the meter with a master meter. The recorded volume of the unit under test during the testing period can be read off directly from the index once the test has been completed and can be compared with the master meter. Testing at a constant flow rate thus ensures the lowest possible level of measurement uncertainty for the unit under test.

Legend

- Δt_N = total master meter testing time in s
- Δt_P = testing time of the unit under test in s
- Q_{max} = maximum flow rate of a gas meter
- Q_{min} = minimum flow rate of a gas meter
- Q_N = flow on master meter in m³/h based on the displayed volume V_N
- $Q_{act,N}$ = actual flow rate on master meter in m³/h
- Q_P = flow determined on unit under test based on V_P in m³/h
- V_N = displayed volume on master meter in m³
- $V_{act,N}$ = actual volume having flowed through the master meter in m³
- V_P = displayed volume on unit under test in m³
Value after C or U in display, depending on device configuration and test method. See test procedure below for further details.
- F_N = error of the master meter in %
- F_P = error of the unit under test in %
- p_N = absolute pressure on the master meter in mbar
- p_P = absolute pressure on the unit under test in mbar
- T_N = absolute temperature on the master meter in K
- T_P = absolute temperature on the unit under test in K
- t_b = base temperature in °C
- V_{b15} = converted volume with reference to $t_b = 15^\circ\text{C}$
- V_b = converted volume with reference to t_b

There are two different options for carrying out the cyclic test:

Option 1: cyclic test at a constant flow rate

- ▷ The test rig is in pre-trial operation, i.e. start of measurement on the unit under test will be delayed.
- ▷ Maintain the flow rate constant.

Test load and minimum test volumes for the test with index readout:

Type	Q_{max} in m ³ /h	Cyclic volume in dm ³	Test volume in dm ³ at		
			Q_{min}	$0.2 Q_{max}$	Q_{max}
BK-G1.6	2.5	1.2	1.2	12	60
BK-G2.5	4.0	1.2	1.2	12	60
BK-G4	6.0	1.2	1.2	12	60
BK-G2.5	4.0	2	2	20	100
BK-G4	6.0	2	2	20	100
BK-G6	10	2	2	20	100
BK-G6	10	4	4	40	200
BK-G6	10	6	6	60	300
BK-G10	16	6	6	60	300
BK-G16	25	6	6	60	300
BK-G25	40	12	12	120	600

- ▷ The minimum test volumes are recommended guide values. The measurement uncertainty of the complete system (test rig plus unit under test) must not exceed 1/3 of the maximum permissible error (MPE).
- ▷ The testing time must be at least 10 s due to the system design.
- ▷ In the test procedure described below, it is guaranteed that the unit under test always performs full measuring unit rotations.

Master meter test procedure

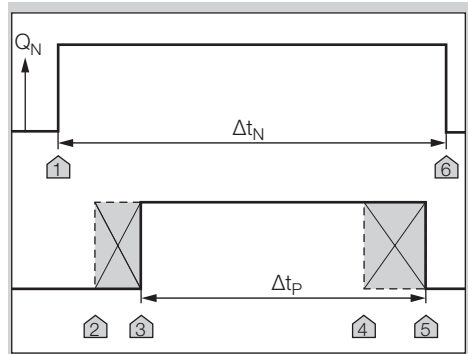

- 1 Set the test flow rate.
 - 2 Start measuring the reference time Δt_N at marker 1.
 - 3 Immediately afterwards, briefly press the selection key ● on the index to start the cyclic test on the unit under test – marker 2. The index will thus be “armed” for measurement.
- ▷ As soon as one of the significant sensor positions has been detected, the unit changes to measuring mode – marker 3. A beep confirms the start of the measurement.

- ▷ Once the required minimum testing time has been reached, the measurement can be terminated – marker 4.

4 Briefly press the selection key ● in order to end the measurement.

- ▷ Measurement on the unit under test stops automatically once the full number of measuring unit revolutions has been completed – marker 5.
- ▷ A beep acknowledges the end of the measurement.
- ▷ Measurement is terminated automatically after 5 hours.

5 Stop the test on the master meter – marker 6.

- ▷ The measurements are then available.

6 Read off the flow rate on the master meter or calculate if necessary:

- a) taking into account the inherent error of the master meter:

$$Q_{act,N} = V_N \times 3600 \text{ s/h} / ((1+F_N/100) \times \Delta t_N)$$

- b) If the inherent error of the master meter has already been taken into account in the displayed volume ($V_N = V_{act,N}$):

$$Q_{act,N} = V_{act,N} \times 3600 \text{ s/h} / \Delta t_N$$

7 Calculate the flow rate on the unit under test:

$$Q_P = V_P / \Delta t_P$$

for BK-G...ET, the following applies: $V_P = V_{b15}$

8 The accuracy is checked by comparing the flow rates. The pressure and temperature values of the unit under test corrected with reference to the master meter have already been taken into account here:

$$F_P = 100\% \times (((Q_P \times p_P \times T_N) / (Q_{act,N} \times p_N \times T_P)) - 1)$$

The following applies:

p_P = relevant absolute pressure on the unit under test

The following also applies:

for BK-G...E: $T_P = (273.15 + \{t_g\}) \text{ K}$

where t_g = relevant gas temperature on the unit under test in °C (display)

for BK-G...ET: $T_P = (273.15 + \{t_b\}) \text{ K}$

where $t_b = 15^\circ\text{C}$ (see page 15 (Technical data)):

$T_P = 288.15 \text{ K}$

for BK-G...ETe:

If Q_P in step 7 is determined from the converted volume V_b , the following applies:

$T_P = (273.15 + \{t_b\}) \text{ K}$ (t_b see page 15 (Technical data))

If Q_P in step 7 is determined from the non-converted volume V_P , the following applies:

$T_P = (273.15 + \{t_g\}) \text{ K}$

where t_g = relevant gas temperature on the unit under test in °C (display)

- ▷ The curly brackets mean “numerical value of”.
- ▷ On a nozzle test rig with a known flow rate, steps **2** and **6** can be omitted.
- ▷ The error calculation is based on PTB Testing Instructions, Volume 29: “Messgeräte für Gas – Gaszähler” (Measuring instruments for gas – gas meters), Edition 2003.

Option 2: cyclic test with a given volume

Test load and minimum test volumes for the test with index readout:

Type	Q_{max} in m^3/h	Cyclic volume in dm^3	Test volume in dm^3 at		
			Q_{min}	$0.2 Q_{max}$	Q_{max}
BK-G1.6	2.5	1.2	36	72	72
BK-G2.5	4.0	1.2	36	72	72
BK-G4	6.0	1.2	36	72	72
BK-G2.5	4.0	2	60	120	120
BK-G4	6.0	2	60	120	120
BK-G6	10	2	60	120	120
BK-G6	10	4	120	240	240
BK-G6	10	6	180	360	360
BK-G10	16	6	180	360	360
BK-G16	25	6	180	360	360
BK-G25	40	12	360	720	720

Master meter test procedure

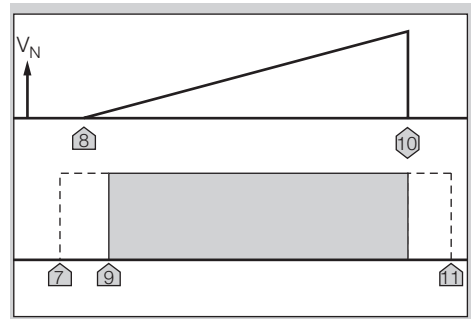

- 1** To activate the cyclic test on the unit under test, briefly press the selection key ● on the index – marker 7. The index will thus be “armed” for measurement.
- 2** Start the test on the master meter – marker 8.
- ▷ As soon as one of the significant sensor positions has been detected, the unit changes to measuring mode – marker 9.
- 3** Test is ended – marker 10.
- 4** Read off the test results on the unit under test.
- ▷ The measured values are updated with each 1/8 revolution of the measuring unit.
- 5** Compare the measurement results with the master meter and determine the measuring deviation on the unit under test:
 - a) taking into account the inherent error of the master meter:

$$F_P = 100\% \times (((V_P \times (1+F_N/100) \times p_P \times T_N) / (V_N \times p_N \times T_P)) - 1)$$
 - b) If the inherent error of the master meter has already been taken into account in the displayed volume ($V_N = V_{act,N}$), the following applies:

$$F_P = 100\% \times (((V_P \times p_P \times T_N) / (V_{act,N} \times p_N \times T_P)) - 1)$$
- ▷ The following applies: p_P = relevant absolute pressure on the unit under test

- ▷ The following also applies:
for BK-G...E: $T_P = (273.15 + \{t_g\}) \text{ K}$
where t_g = relevant gas temperature on the unit under test in °C (display)
for BK-G...ET: $T_P = (273.15 + \{t_b\}) \text{ K}$
where $t_b = 15^\circ\text{C}$ (see page 15 (Technical data)):
 $T_P = 288.15 \text{ K}$
for BK-G...ETe:
If the converted volume V_b is taken for V_P :
 $T_P = (273.15 + \{t_b\}) \text{ K}$ (t_b see page 15 (Technical data))
If the non-converted volume V_P is taken for V_P :
 $T_P = (273.15 + \{t_g\}) \text{ K}$
where t_g = relevant gas temperature on the unit under test in °C (display)

- ▷ The curly brackets mean "numerical value of".
- 6** Stop execution of the cyclic test – marker 11. Briefly press the selection key **●** twice in order to stop the measurement.
- ▷ A beep confirms interruption of the measurement.
- ▷ Measurement is terminated automatically after 5 hours.
- ▷ The error calculation is based on PTB Testing Instructions, Volume 29: "Messgeräte für Gas – Gaszähler" (Measuring instruments for gas – gas meters), Edition 2003.

Pulse test

The pulse test is designed for checking the meter with a master meter. The recorded volume is provided by pulses which are emitted via the optical interface. Test load and minimum test volumes for the test with index readout:

Type	Q_{\max} in m^3/h	Cyclic volume in dm^3	Test volume in dm^3 at		
			Q_{\min}	$0.2 Q_{\max}$	Q_{\max}
BK-G1.6	2.5	1.2	36	72	72
BK-G2.5	4.0	1.2	36	72	72
BK-G4	6.0	1.2	36	72	72
BK-G2.5	4.0	2	60	120	120
BK-G4	6.0	2	60	120	120
BK-G6	10	2	60	120	120
BK-G6	10	4	120	240	240
BK-G6	10	6	180	360	360
BK-G10	16	6	180	360	360
BK-G16	25	6	180	360	360
BK-G25	40	12	360	720	720

- ▷ Pulse value V_{Imp} , see page 15 (Technical data).
- ▷ This test can only be carried out when the optical communications link has been established. The procedure depends on your user software.
- 1** Establish the optical communications link, see page 7 (Establishing an optical communications link).
- 2** Interrupt communication to the installed communication modules before starting the test so that the measurement accuracy will not be adversely affected.

As of step 3, continue as described in one of the two following sections.

Pulse test at a constant flow rate (optical interface)

Master meter test procedure

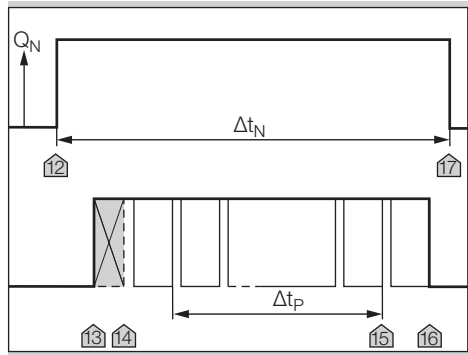

- 3** Set the test flow rate.
- 4** Start measuring the reference time Δt_N at marker 12.
- ▷ Marker 12 indicates the release of the test flow rate on the master meter.
- 5** Immediately afterwards, start the pulse test on the unit under test – marker 13.
- ▷ Then the unit under test generates the volume pulses on the optical interface each time the lowest-order decimal place on the meter display is incremented – marker 14. The test begins.
- 6** As soon as the required minimum test volume has been reached on the unit under test, the time measurement on the unit under test can be stopped – marker 15.
- 7** End the pulse test using any command – marker 16.
- ▷ Measurement is terminated automatically after 90 minutes.
- 8** Shut off the gas flow to the master meter – marker 17.
- 9** Determine the volume on the unit under test V_P :
 $V_P = N \times V_{\text{Imp}}$
 N = number of pulses during Δt_P
 V_{Imp} = pulse value V_{Imp} , see page 15 (Technical data)
- 10** Calculate the flow rate on the unit under test:
 $Q_P = V_P / \Delta t_P$
- 11** Read off the flow rate on the master meter or calculate if necessary:
 - a) taking into account the inherent error of the master meter:
 $Q_{\text{act},N} = V_N \times 3600 \text{ s/h} / ((1+F_N/100) \times \Delta t_N)$
 - b) If the inherent error of the master meter has already been taken into account in the displayed volume ($V_N = V_{\text{act},N}$):
 $Q_{\text{act},N} = V_{\text{act},N} \times 3600 \text{ s/h} / \Delta t_N$

- 12** The accuracy is checked by comparing the flow rates. The pressure and temperature values of the unit under test corrected with reference to the master meter have already been taken into account here:

$$F_P = 100\% \times \left(\frac{(Q_P \times p_P \times T_N)}{(Q_{act,N} \times p_N \times T_P)} - 1 \right)$$

The following applies:

p_P = relevant absolute pressure on the unit under test

The following also applies:

$$\text{for BK-G...E: } T_P = (273.15 + \{t_g\}) \text{ K}$$

where t_g = relevant gas temperature on the unit under test in °C (display)

for BK-G...ET and BK-G...ETe:

$$T_P = (273.15 + \{t_b\}) \text{ K (} t_b \text{ see page 15 (Technical data))}$$

- ▷ The curly brackets mean "numerical value of".
- ▷ On a nozzle test rig with a known flow rate, step **4** can be omitted.
- ▷ The error calculation is based on PTB Testing Instructions, Volume 29: "Messgeräte für Gas – Gaszähler" (Measuring instruments for gas – gas meters), Edition 2003.

- 13** Recommision the previously switched off communication modules.

Pulse test with a given volume

Master meter test procedure

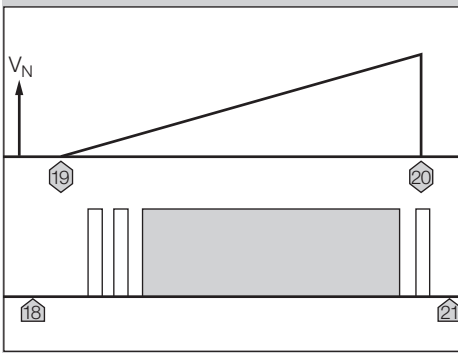

- 3** Start the pulse test on the unit under test – marker 18.
- 4** Start the test on the master meter – marker 19.
- 5** Record the pulses from the unit under test.
 - ▷ The unit under test generates the volume pulses on the optical interface each time the lowest-order decimal place on the index display is incremented.
- 6** The test volume is achieved and the test ends – marker 20.
- 7** End the pulse test on the unit under test using any command – marker 21.
 - ▷ Measurement is terminated automatically after 90 minutes.

- 8** Determine the volume on the unit under test V_P :

$$V_P = N \times V_{Imp}$$

N = number of pulses

V_{Imp} = pulse value in m^3

- 9** Read off the volume on the unit under test.

The inherent error of the master meter is to be taken into account if applicable:

$$V_{act,N} = V_N / (1 + F_N/100)$$

- 10** Determine the measuring deviation on the unit under test:

$$F_P = 100\% \times \left(\frac{(V_P \times p_P \times T_N)}{(V_{act,N} \times p_N \times T_P)} - 1 \right)$$

- ▷ The pressure and temperature values of the unit under test corrected with reference to the master meter have already been taken into account here.

The following applies:

p_P = relevant absolute pressure on the unit under test

The following also applies:

$$\text{for BK-G...E: } T_P = (273.15 + \{t_g\}) \text{ K}$$

where t_g = relevant gas temperature on the unit under test in °C (display)

for BK-G...ET and BK-G...ETe:

$$T_P = (273.15 + \{t_b\}) \text{ K (} t_b \text{ see page 15 (Technical data))}$$

- ▷ The curly brackets mean "numerical value of".
- ▷ The error calculation is based on PTB Testing Instructions, Volume 29: "Messgeräte für Gas – Gaszähler" (Measuring instruments for gas – gas meters), Edition 2003.

- 11** Recommision the previously switched off communication modules.)

RTC test

- ▷ The climatic conditions must be maintained constant at $22 \pm 5^\circ\text{C}$ during the entire test duration. Temperature changes in 24 hours $\leq 2 \text{ K}$.
- ▷ Ensure that conditions remain sufficiently stable during the measurement.
- ▷ The accuracy of the time count can be verified with this test.

- 1** Acclimatize the unit under test and place next to the time reference unit.
- 2** If necessary, activate the time display on both units.
- 3** Ensure synchronous reading by taking a photo.
- 4** Observe a min. testing time of 24 hours.
- 5** Repeat steps **2** and **3**.
- 6** The clock deviation of the unit under test must not exceed the maximum admissible deviation. Maximum admissible deviation = 100 ppm in 24 hours.

Temperature test

- ▷ A temperature test is required on diaphragm gas meters with temperature conversion BK..Te only.
- ▷ The accuracy of the temperature measurement can be verified with this test.
- ▷ The temperature test can only be carried out in Service mode.

! CAUTION

To avoid damage to the unit:

- Comply with ambient temperature, see page 15 (Technical data). Deviations from the permitted ambient temperature will be recorded in the error memory.
- ▷ Temperature measurement accuracy, see page 15 (Technical data).
- 1** Install the diaphragm gas meter in a climatic chamber.
- 2** Activate Service mode – see page 5 (Service mode).
- 3** Change to the “Temperature” menu.
 - ▷ The current gas temperature is displayed.
- 4** Close the climatic chamber.
- 5** Select an ambient temperature as a reference value and bring the climatic chamber to this temperature.
 - ▷ To ensure there is also a uniform temperature in the meter, we recommend starting the meter air/gas flow during the temperature adjustment phase.
 - ▷ Ensure that temperature distribution remains uniform and stable during the temperature measurement.
- 6** Compare the measured value to the temperature reference value.
 - ▷ If required, several reference values can be checked. In this case, repeat the test as of point **5**.

Assistance in the event of malfunction

- ? **Fault**
- ! **Cause**
- **Remedy**

Possible faults and suggested solutions

- ? **The Δ symbol is displayed.**
 - ! If the Δ symbol appears next to a measured value, this means that the value is invalid.
 - After the next data synchronization, the data are recorded again correctly and Δ disappears.
- ? **When pressing the user keys, the backlighting and/or display remain switched off. A beep can nevertheless be heard.**
 - ! Energy-saving mode is active. Due to excessive use of the index, the average energy consumption has been exceeded.

- Leave the index unused for an extended period, e.g. 24 hours. After this, the user interface will once again be available.

- ? **When pressing the user keys, the display remains switched off and no beep can be heard.**

- ! The index is defective.
- Contact the manufacturer.

- ? **The \square symbol is displayed.**

- ! Low battery. This symbol is only displayed when battery power is low.
- Replace the battery.

- ▷ In the case of faults which are not described here, contact the manufacturer immediately.

Spare parts

Battery

For meters without communication module:

Elster Part No.: 32906520.

For meters with communication module:

Elster Part No.: 72910321.

Communication module

Use ATEX compliant communication modules only.

A safety sticker with the following code must be attached to the communication module:

$\text{II 3G Ex ic IIA Gc } (-25^{\circ}\text{C} \leq \text{Ta} \leq +55^{\circ}\text{C})$.

Electrical connection parameters, see page 15 (Technical data).

Screw locking cap

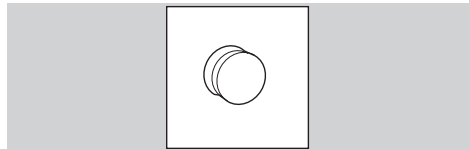

Elster Part No.: 32447510.

Technical data

Application with diaphragm gas meters BK..E
RoHS compliant
Enclosure: IP 54.
Battery life: approx. 10 years.
Maximum allowable ambient temperature range: see type label/index plate.
Data logger for historic meter readings:
up to 60 weeks in 30-minute intervals.
Optical interface: pursuant to EN 62056-21, Mode (E), Annex B.2.
Accuracy of the clock: 0.4 s/day at 20°C on the day of manufacture.
Diaphragm gas meter BK..ETe with temperature conversion:
Temperature measurement accuracy: $\pm 1^\circ\text{C}$ on the day of manufacture.
The base temperature t_b is specified on the index plate.

Pulse output of optical interface

Pulse value V_{Imp} :

Gas meter	Decimal place in display	Pulse value V_{Imp} in dm^3
BK-G 1.6–BK-G 6	3	1
BK-G 10–BK-G 25	2	10

Pulse duration: 90 ms

For further technical data on diaphragm gas meters BK – see the operating instructions for diaphragm gas meters BK-G1.6 to BK-G25 → http://docuthek.kromschroeder.com/doclib/main.php?language=1&folderid=400041&by_class=2&by_lang=-1.

ATEX explosion protection

Battery

Only use approved batteries from Elster.
The “Battery pack cpl. El2” is certified as part of the electronic index.

Communication modules

Please contact the manufacturer for details on suitable communication modules. Information on the ATEX suitability can be found in the operating instructions of the respective communication module.
The UMI interface features the following parameters:

- $U_O = 3.9\text{ V peak, } 3.6\text{ V nominal,}$
- $I_O = 7.5\text{ A peak, } 506\text{ mA nominal,}$
- $P_O = 1.55\text{ W,}$
- $C_O = 12\ \mu\text{F,}$
- $L_O = 50\text{ nH.}$

For more data on explosion protection of diaphragm gas meters BK – see the operating instructions for diaphragm gas meters BK-G1.6 to BK-G25 → http://docuthek.kromschroeder.com/doclib/main.php?language=1&folderid=400041&by_class=2&by_lang=-1.

Logistics

Transport

Diaphragm gas meters are always to be transported in the upright position. On receipt of the product, check that the delivery is complete, see page 2 (Part designations). Report any transport damage immediately.

Storage

Diaphragm gas meters are always to be stored in the upright position and in a dry place. Ambient temperature: see page 15 (Technical data).

Disposal

Meters with electronic components:
Components, particularly batteries, are to be disposed of separately.

On request, old units may be returned carriage paid to the manufacturer, see page 16 (Contact), in accordance with the relevant waste legislation requirements.

Contact

Honeywell

Germany

Elster GmbH
Strotheweg 1
49504 Lotte
Tel. +49 541 1214-0
Fax +49 541 1214-370
info@elster-instromet.com
www.elster-instromet.com

United Kingdom

Elster Metering Limited
Paton Drive
Tollgate Business Park
Beaconside
Stafford, ST16 3EF
Tel. +44 1785 275200
Fax +44 1785 275305
jeavons.info@gb.elster.com
www.elstermetering.co.uk

Ireland

Active Energy Control Ltd.
Unit 4, Clare Marts
Quin Road
Ennis, Co. Clare
Tel. +353 65 6840600
Fax +353 65 6840610
info@aec.ie
www.aec.ie